

# CHICKEN COOP

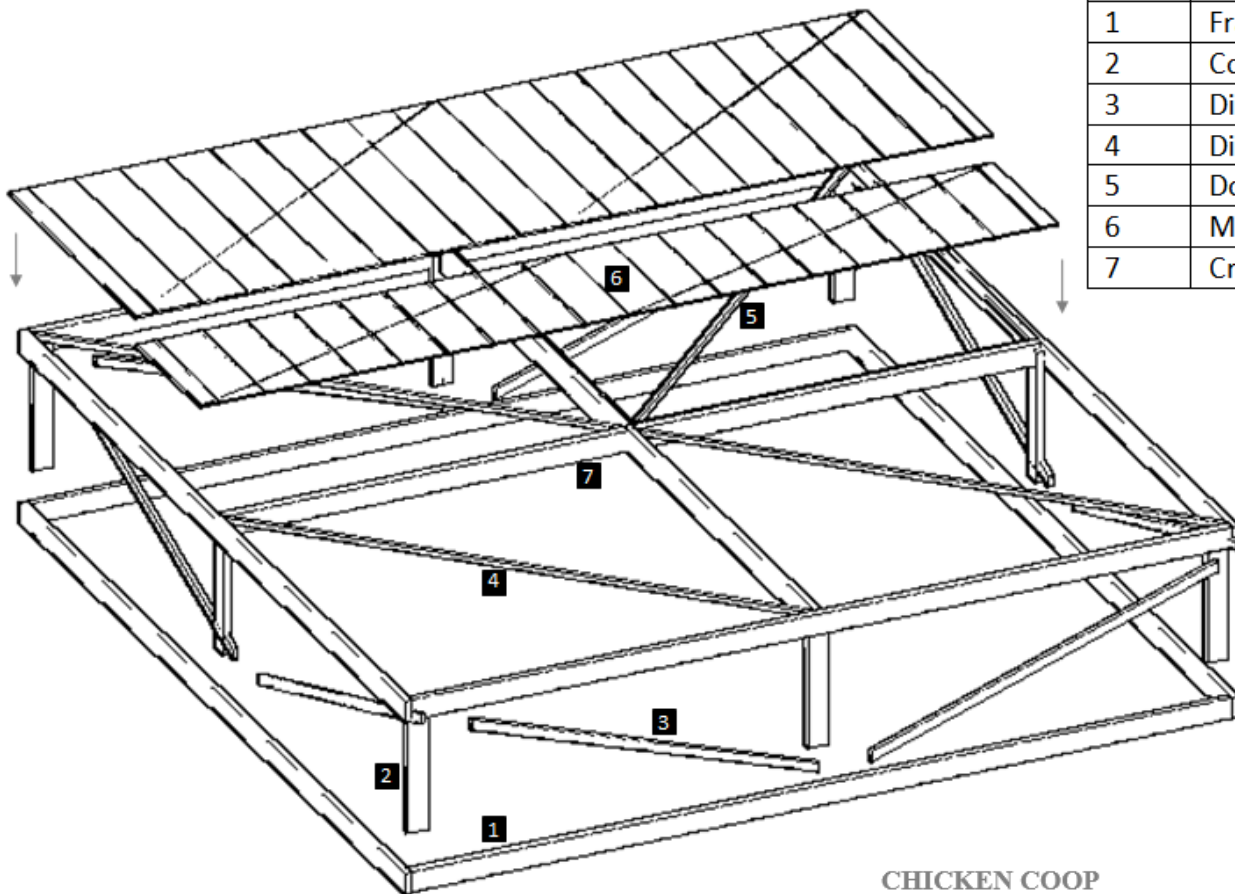

#	Name
1	Frame
2	Corner Supports
3	Diagonal 1
4	Diagonal 2
5	Door Frame
6	Metal Roof
7	Cross Supports

**Step 1:** To build the Frame use 2x4s as shown below, using the 3" wood screws or nails. Then, use 2x4s for the corner and central supports.

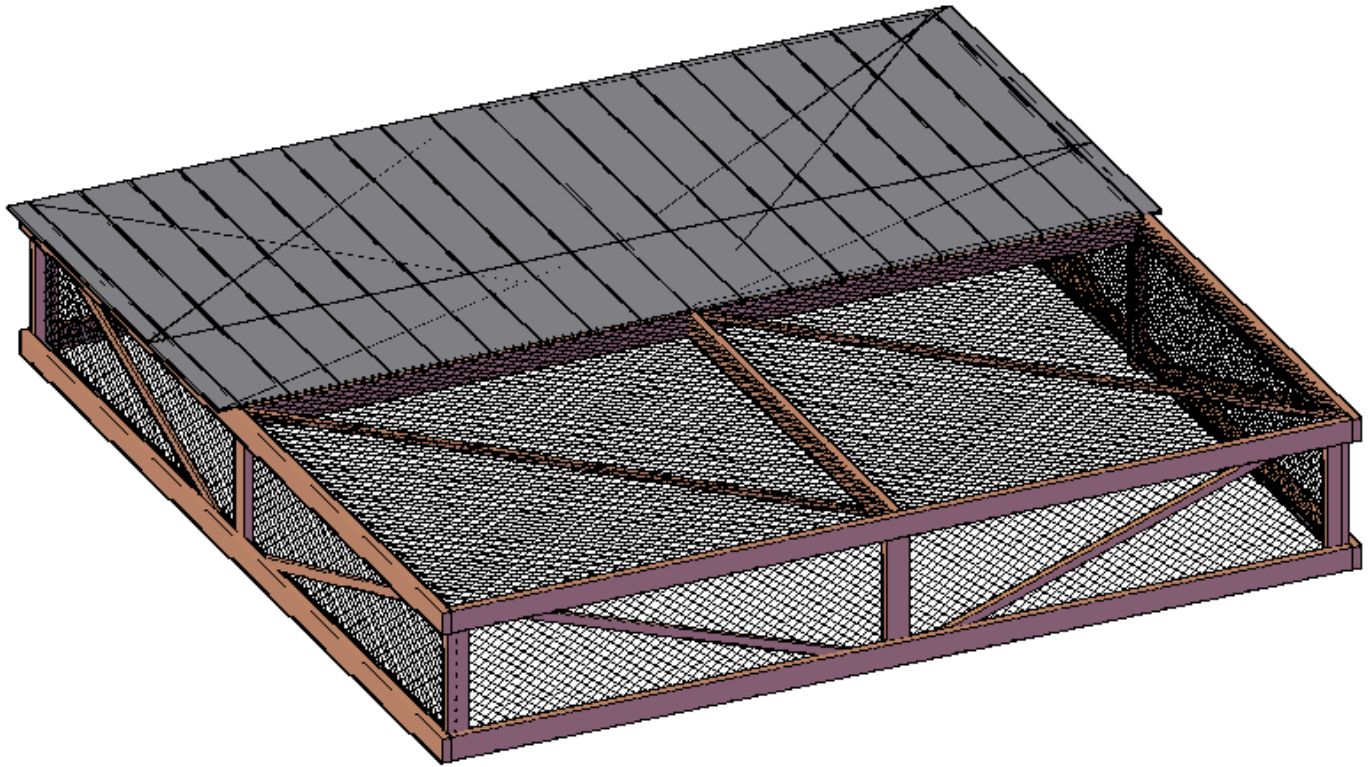
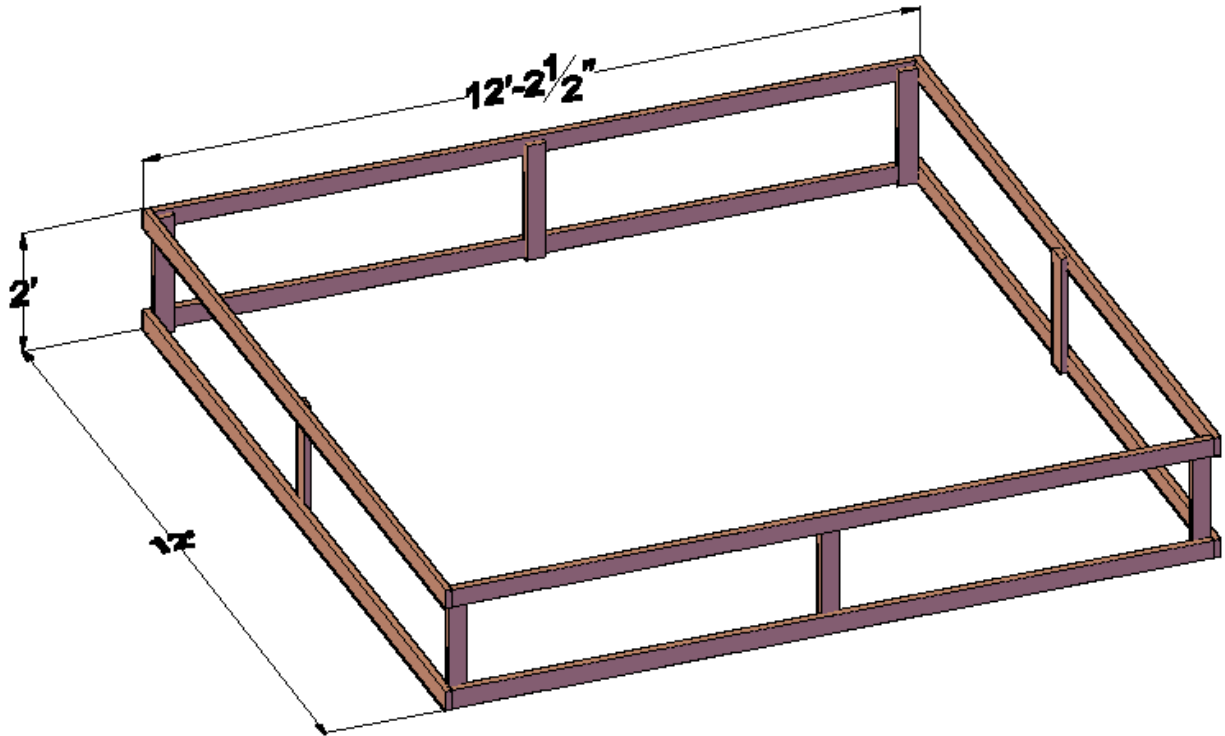

**Step 2:** For cross supports use 2x4s as shown below and attach with 3" wood screws or nails.

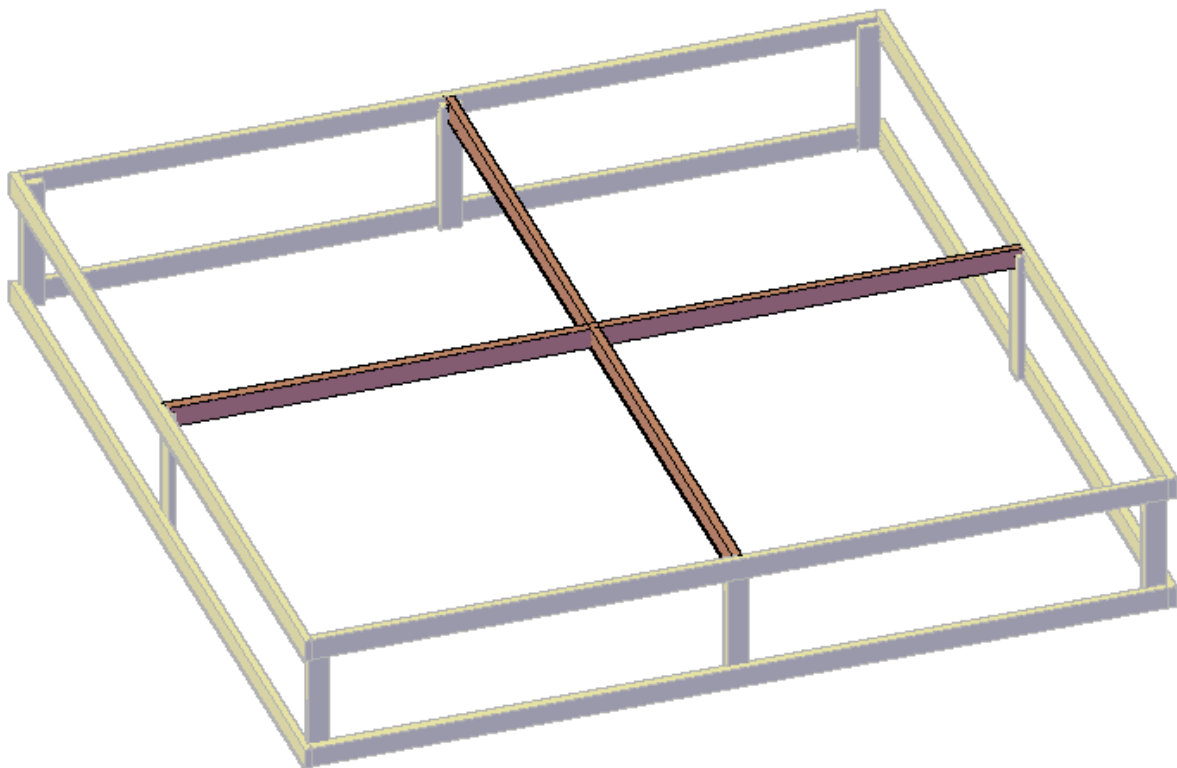

**Step 3:** Attach the lateral and upper diagonals supports with 3'' deck screws.

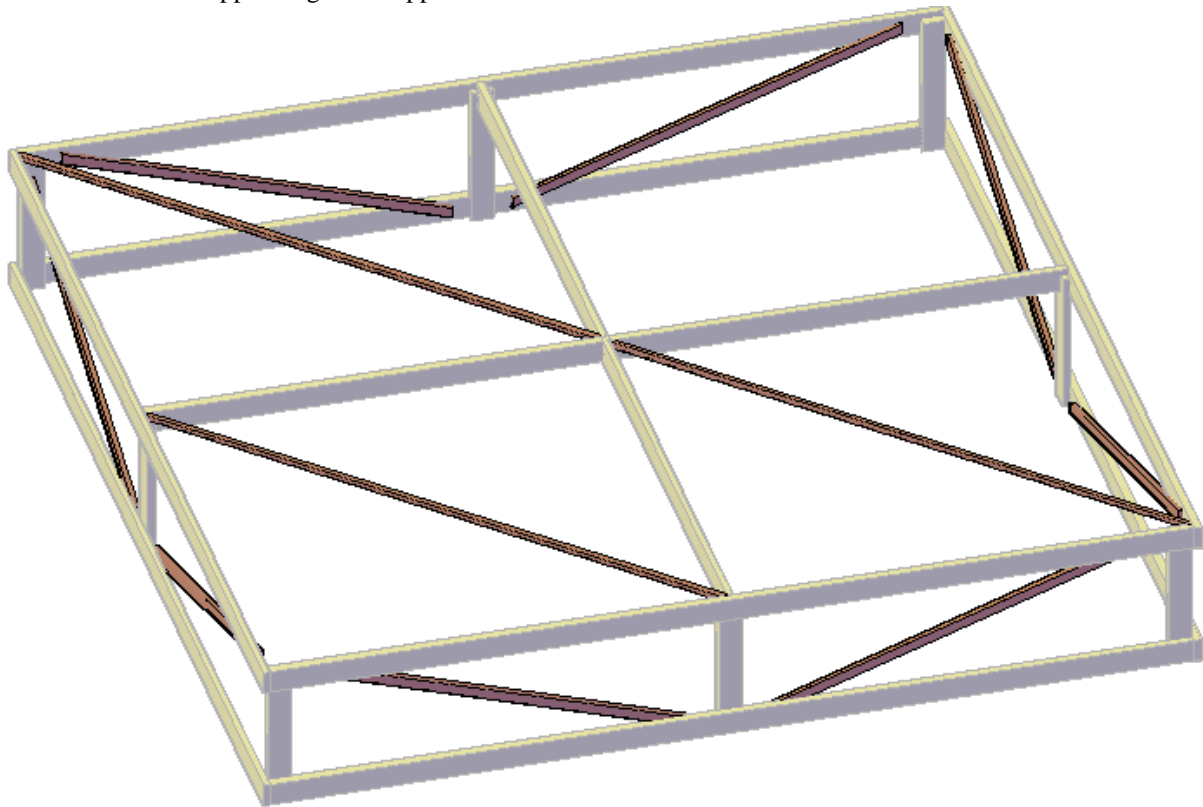

**Step 4:** Use hinges to attach the door frame.

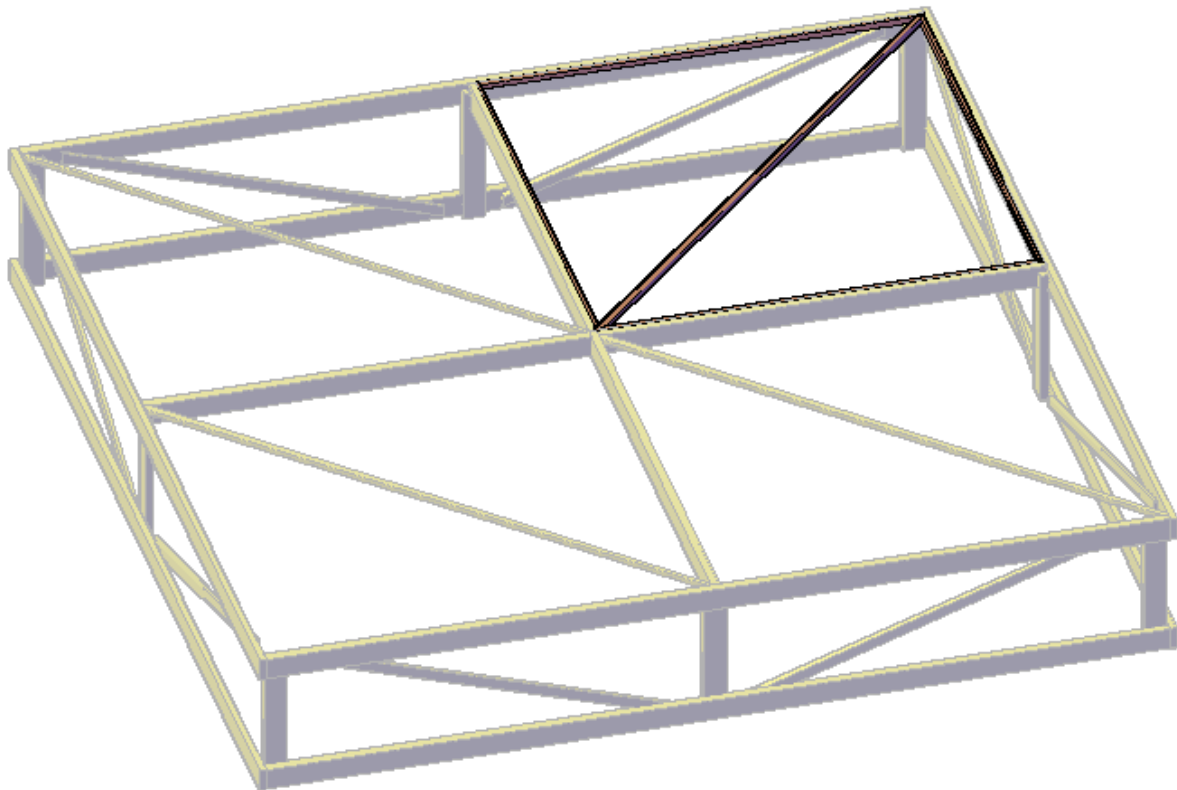

**Step 5:** Use Chicken wire for the perimeter and part of the top.

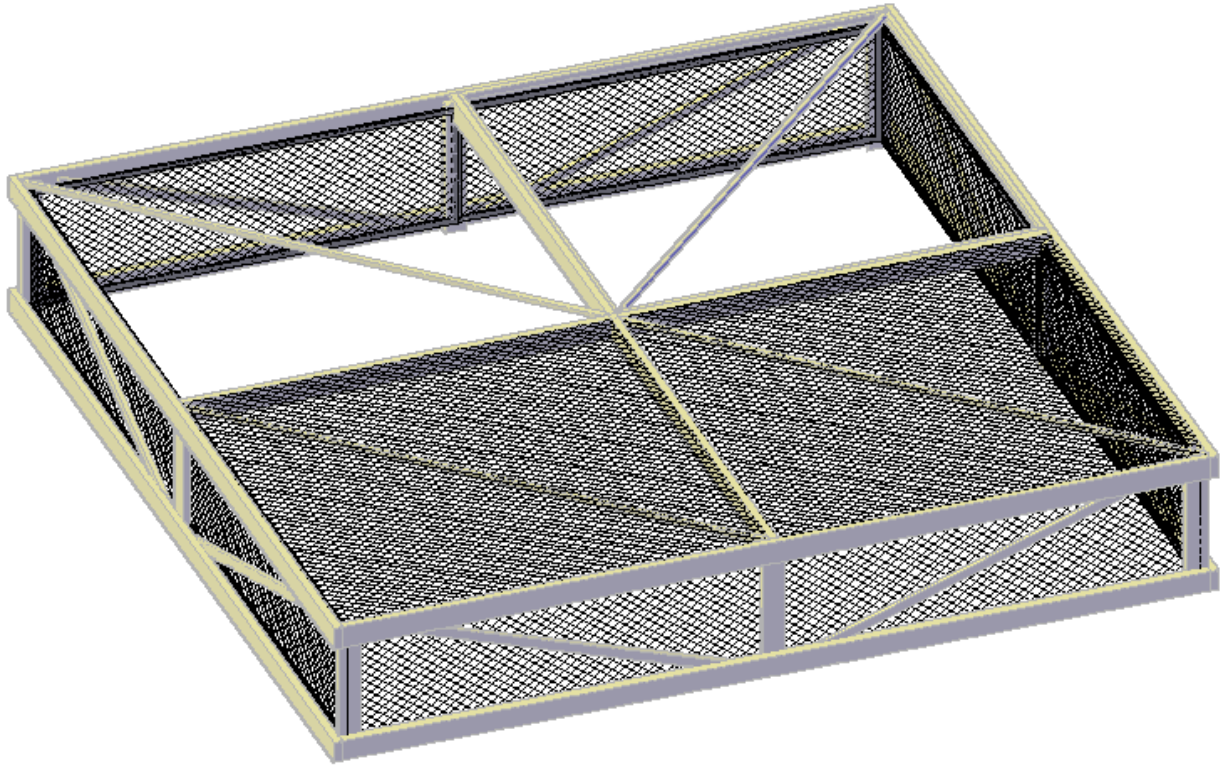

**Step 6:** Finally, use metal roof.

